

VISIBLE LIGHT EMITTING DIODE

DATA SHEET

MODEL NO: GT5-3G18D10G

REV. : 2.0

DATE : 11-MAY.-2009

■ DESCRIPTIONS:

- 5mm Round lamp
- Lens color: Green Diffused
- Emitting Color: Bright Green
- No Stopper
- Dice Material: GaP



■ APPLICATIONS:

- TV set
- Monitor
- Telephone
- Computer
- circuit board

■ ABSOLUTE MAXIMUM RATINGS (Tamb=25,unless otherwise specified)

Parameter	Test condition	Symbol	Ratings	Unit
Forward Current		IF	20	mA
Power Dissipation		PD	50	mW
Peak Forward Current	tp/T=0.1, tp=100μs	IFP	100	mA
Reverse voltage		VR	5	V
Operating Temperature		Topr	-40~+85	°C
Storage Temperature		Tstg	-40~+100	°C
Soldering Temperature		Tsol	260°C for 5 sec Max (2mm from Body)	

Basic Characteristics (Tamb=25, unless otherwise specified)

Parameter	Symbol	Min.	Type	Max.	Unit	Test Condition
Forward Voltage	VF		2.0	2.5	V	IF=20mA
Luminous Intensity	Iv	-	200	400	mcd	IF=20mA
Reverse Current	IR			80	μA	VR=5V
Peak Wavelength	λp		560	565	nm	IF=20mA
Dominant Wavelength	λp	565			nm	IF=20mA
View Angle	2θ1/2		20		deg	IF=20mA

● Dimensions:

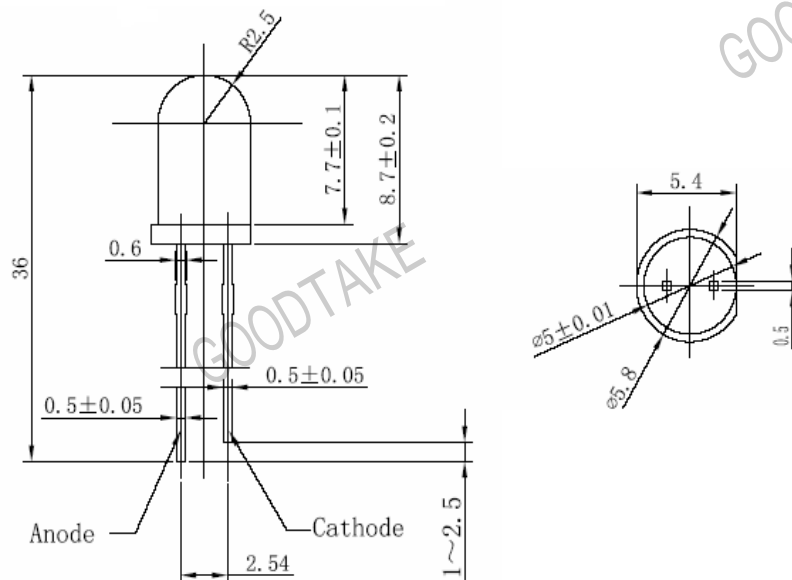

NOTE: 1. All dimensions are in millimeter, tolerance is ±0.5 unless otherwise noted.
 2. Epoxy meniscus extends ≤1 mm down to the lead is allowed.

■ **Typical electro-optical characteristics curves**

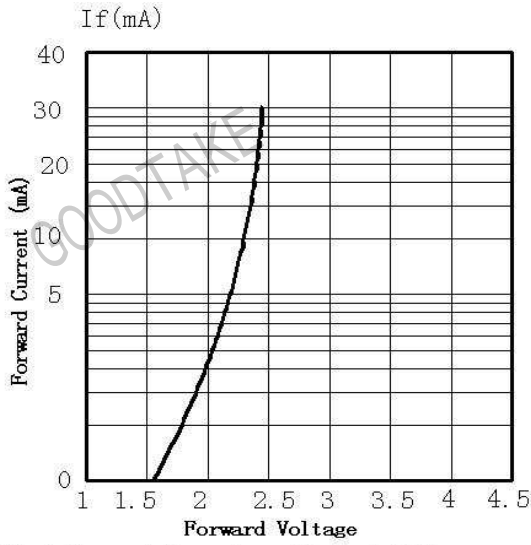

Fig. 1 forward Current vs. Forward Voltage

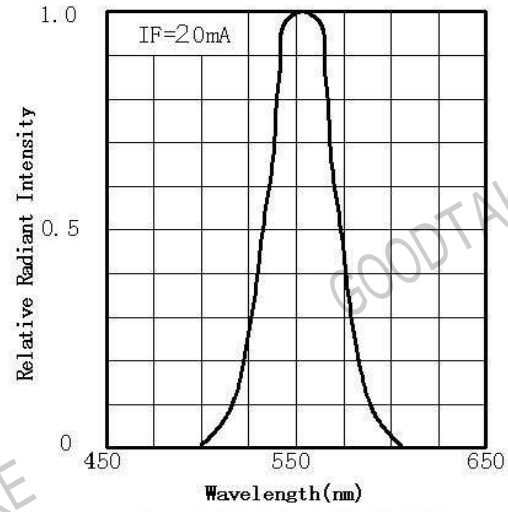

Fig. 2 Spectral Distribution

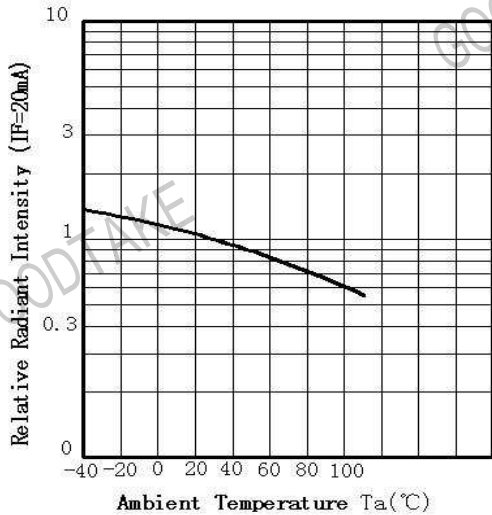

Fig. 3 Ambient Radiant Intensity Vs Ambient Temperature

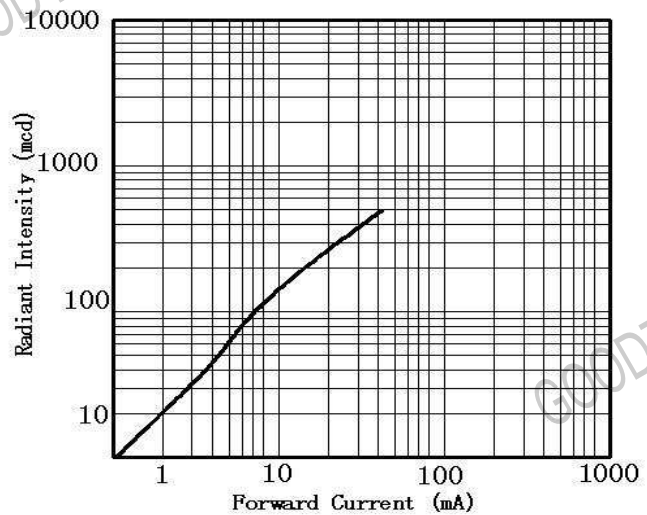

Fig. 4 Forward Current Vs Radiant Intensity

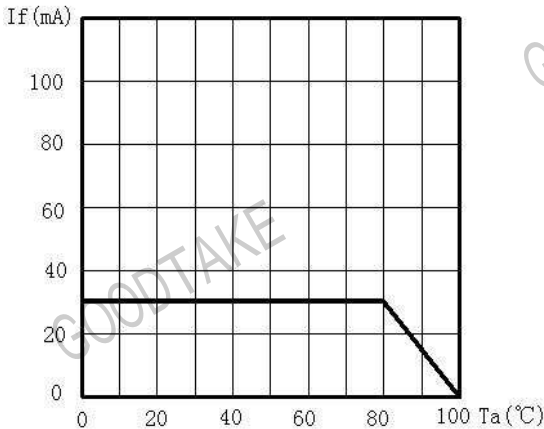

Fig. 5 Maximum Forward Current Vs Ambient Temperature

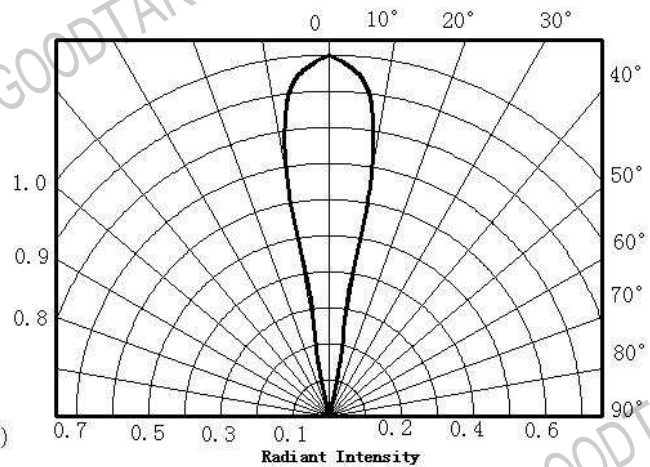

Fig. 6 Angle Vs Radiant Intensity